



Newland

SCANNING MADE SIMPLE



BS10R Sepia ring scanner user guide

Precautions

1. Please read the user manual carefully before using this barcode scanner.
2. The working voltage of this barcode scanner is 3.3V, charging voltage 5V. Please use our original USB cable and AC power adapter to ensure the scanner is working properly.
3. Copyright and Patent Notice Our company reserves the copyright, software copyright and sufficient patents of the ring barcode scanner and its accessories(including firmware, MR Configurator,illustration documents,appearance and so on.)
4. Our company reserves all rights, reserves the right to make any changes to the product to improve its reliability, function or design. Our company shall not be liable for applications or use of any product or circuit with our scanner, or any liability arising therefrom or in connection with any other applications described herein.
5. Our wireless barcode scanner accessories:
A: standard package: : barcode scanner (1 piece), AC power adapter , USB cable (1 piece), user manual (1 piece).
6. The contents of this manual are subject to change without prior notice.

Content

1.Notice.....	1
2.Introduction and Features.....	3
3.Application & Execution Standards.....	4
4.Working Conditions& Related regulations.....	5
5.Appearance.....	6
6.Installation of USB Cable.....	7
7.Reset Configuration to Defaults+Pair with PC terminals HID bluetooth mode.....	8
8.Pull up and Hide Keyboard of IOS System.....	9
9.Sound and Vibration Setting.....	10
10.Sleep Time Setting.....	11
11.Language Settings.....	12
12.End Character Setting.....	13
13.Transmission Speed Setting and Bluetooth protocol.....	14
14.Operating Mode.....	15-16
15.Bluetooth Name Change Setting.....	17
16.Hide front and back characters.....	18-19
17.Set Prefix and Suffix Setting.....	20
18.Appendix A.....	21-31
19.FAQ(Frequently Asked Questions).....	32
20.Buzzer and Indicator Light State.....	33

Introduction

The series of barcode scanner produced by our company feature as strong light source, enhanced long-distance scanning technology. It can read the damaged, stained and poor printed barcode fast under different ambient light conditions.

It is durable in use, since it is protected by the industrial safety technique. High volume buzzer is another hint of success scanning besides LED light in the noisy industrial environment.

Features

Wired and wireless dual mode freely switching.

One-click matching with various PCs

Outdoor 30 meters visual transmission distance (Bluetooth transmission mode).

Large capacity storage, safe and reliable.

In storage mode stores barcodes more than 50,000pcs.

Support normal mode, storage mode and switch freely.

Support Windows XP、Win7、Win8、Win10、operating system PC & Android devices and iOS devices.

Support Bluetooth HID protocol, SPP protocol and BLE protocol (Bluetooth Transmission Mode).

Unit power management system, ultra-long standby time.

Rich symbologies supported.

Adopting imported trigger button, long life, fitting perfectly in your hand for comfortable use.

Application

* Applicable to Business (electrical, book, clothing, medicine, cosmetics, etc.), retail industry, postal service, telecommunications industry, warehousing, logistics industry, public security system, customs systems, banking system, medical system.

* Compatible with Microsoft, Android, Linux and other operating systems and bluetooth protocol

* Support multi-national keyboard language

Scanner Execution Standards

Performance Parameter

A dual-mode scanner: wired and wireless, switch freely.

Wireless transmission protocol: Bluetooth

Storage: 16Mb

Decoding chip: ARM Cortex 32 bits

Bluetooth module: Bluetooth 4.1 Module

Support bar code 2D: PDF417, Data Matrix (ECC200, ECC000, 050, 080, 100, 140), QR Code.

1D: Code 128, EAN-13, EAN-8, Code 39, UPC-A, UPC-E, Codabar, Interleaved 2 of 5, ITF-6, ITF-14, ISBN, Code 93, UCC/EAN-128, GS1 Databar Matrix 2 of 5, Code 11, Industrial 2 of 5, Standard 2 of 5, Plessey, MSI-Plessey

Indicator: LED light, Buzzer, Vibration (Optional)

Charging voltage / current: 5V/1A

Time of Endurance: Continuously Work 8 Hours under Normal Temperature (5 Second/scan)

Charging Time: < 2 hours

Standby time: > 30 days

Working Conditions

- Working Temperature: 32°F to 104°F/0°C to 40°C
- Storage Temperature: -40°F to 140°F/-40°C to 60°C
- Humidity: 5% to 95% relative humidity (no condensation)
- Ruggedness: Resist about 6 times drops from 1.5m to concrete ground
- Ambient Light Immunity: Under normal office and factory ambient lighting conditions, or exposed to the sun won't take any effect to it.
- Electrostatic discharge: In line with 15KV air discharge and 8KV contact discharge requirements

Related Regulations

- Electrical safety: In accordance with UL1950、CSA C22.2 No.950、EN60950/IEC950 EMI/RFI:FCC Part 15 Class B、European Union EMC Directive、Taiwan EMC、
- Environment Terms: In accordance with RoHS directive 2002/95/EEC

Appearance

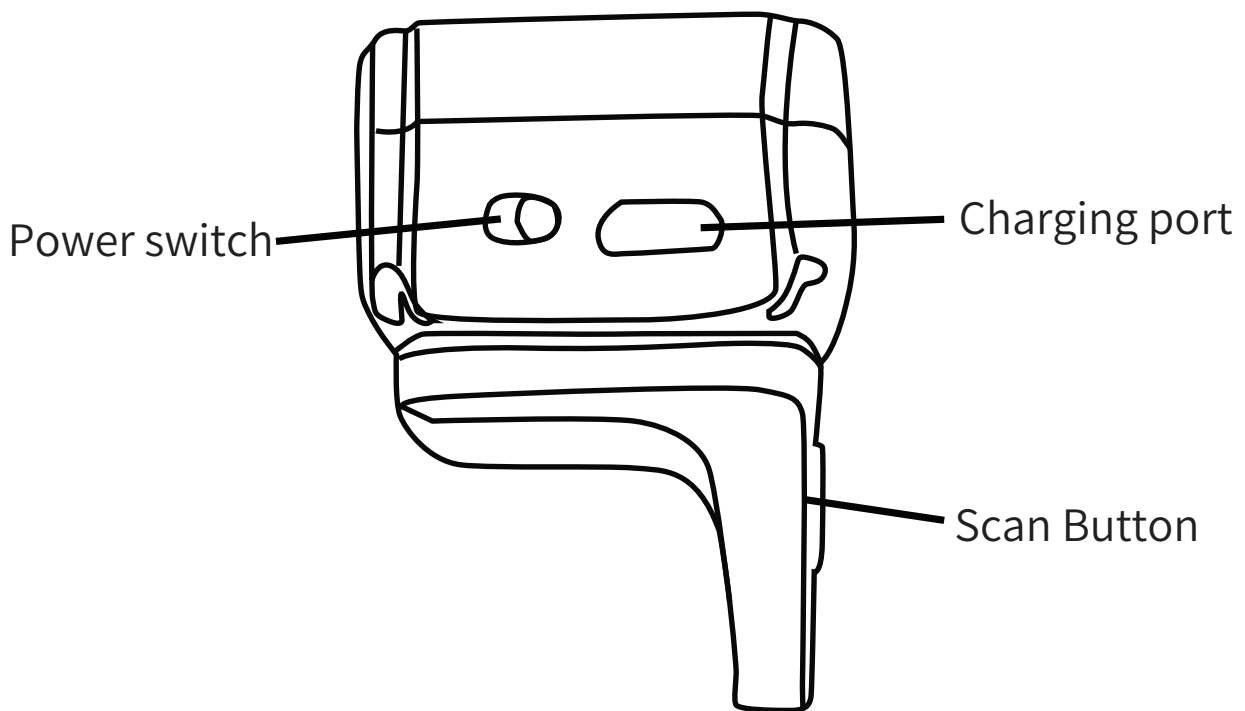
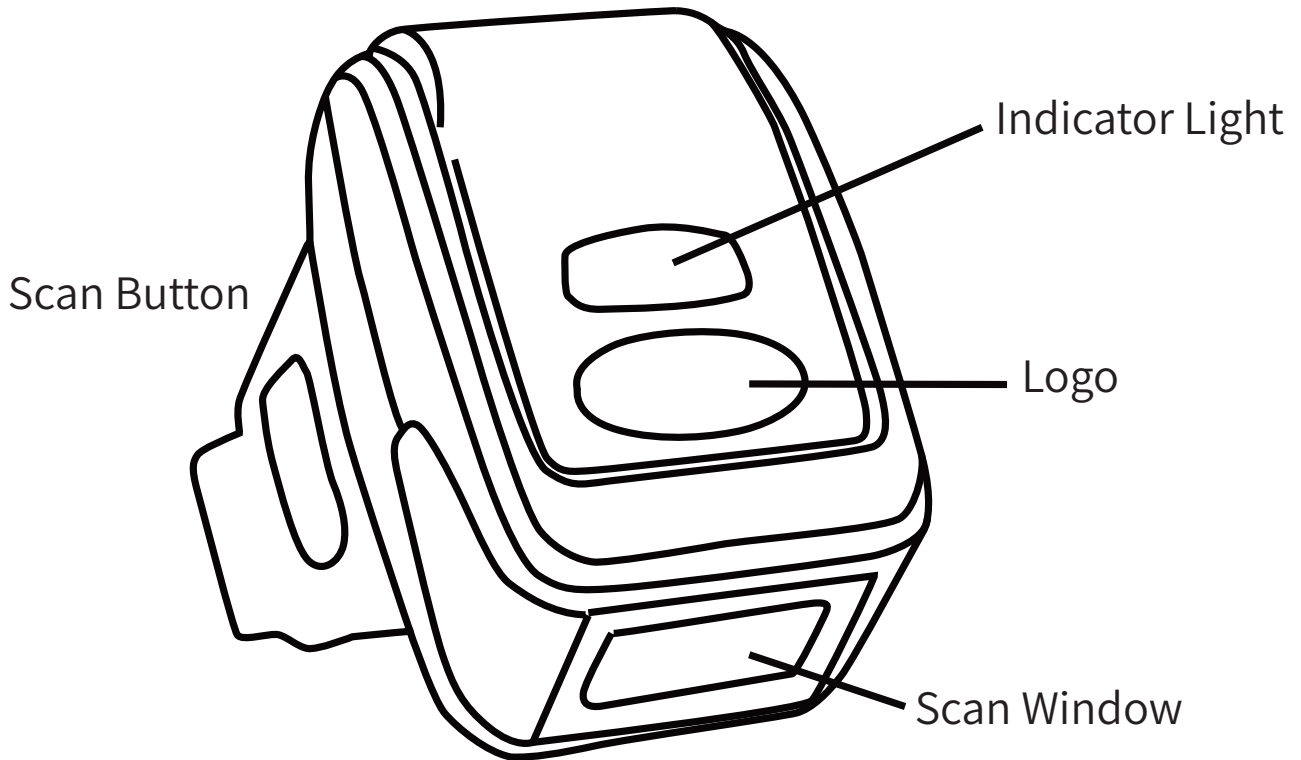

Installation of Cable USB Cable Installation

sample graph

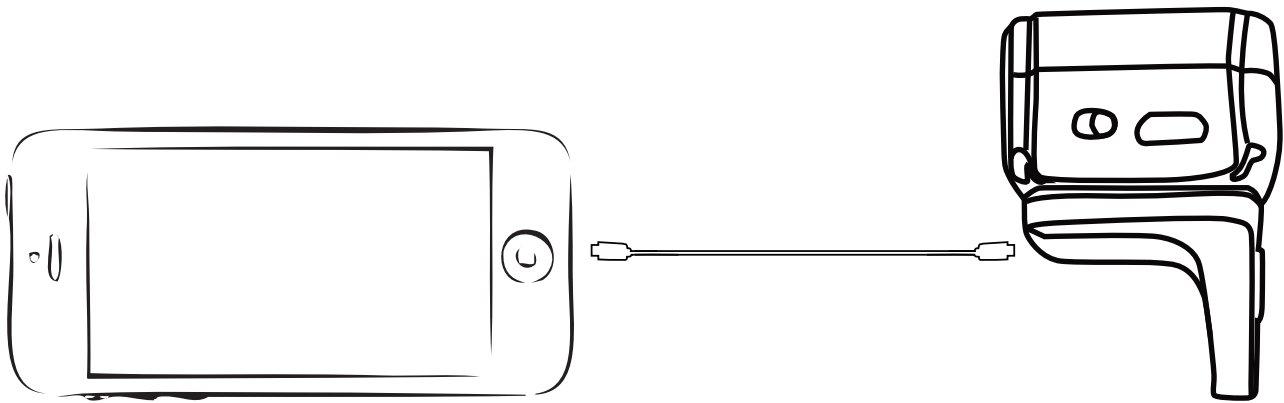

Each barcode scanner is with one USB cable., For connection, please refer to above sample diagram.

Noted: Computer host can charge scanner via USB cable and USB cable can also be used as a wire to transmit barcodes.

The installation method is as follows:

1. Connect USB cable's Square Side interface to the bottom of the scanner;
2. Connect the other side of USB to the computer host.
3. Our barcode scanner features with wireless transmission mode and USB cable transmission mode. When triggered to wake up, the scanner will automatically identify whether the USB cable is connected. If identify, it will work in USB cable transmission mode, data transmitted via USB cable; If not, will work in wireless transmission mode, data transmitted via Bluetooth wireless .

Initialization Setting&Version Information

During usage,if you scan other set-up barcode by mistake and the scanning cannot perform as normal way, you can scan the initialization set-up barcode to revert.



Initialization Setting



Display Version Information

Pair with Android, iOS operating system smartphones or tablets or PC terminals that with Bluetooth function (Bluetooth Pairing Steps)

A.Start the scanner and long press for 8 seconds to enter "Bluetooth HID Pairing Mode" .



HID Pair Set-up Barcode

B: Turn on Bluetooth in the device to detect bluetooth device named with "Barcode Scanner HID".Click "Barcode Scanner HID" to enter pairing status.: If pair successfully, you will hear a beep.

Note: When the scanner enters the state of matching and it does not pair withbluetooth successfully within 1 minute, there is 2 times long low sound indicated failing match and return to scanning mode.

Pull up and Hide Keyboard of IOS System



Pull up and Hide Keyboard of IOS System



Trigger twice to pull up iOS keyboard



Trigger twice to disable iOS keyboard

Sound and Vibration Setting.

Select the desired to turn on/off the sound or vibration set-up barcode



Turn off the Sound



Turn on the Sound



Vibration off (optional)



Vibration on (optional)

Dormancy time Setting



dormancy after 1 min



dormancy after 5 mins



dormancy after 10 mins



dormancy after 30 mins



Never enters dormancy



dormancy fastly

Keyboard Language Settings.



English



German



French



Spanish



Italian



Japanese

End Character Setting

Select the end barcode you want to add



Add CR



Add LF



Add CR+LF



Cancel CR+LF



Add TAB

Transmission Speed Setting

Select the corresponding transmission speed according to PC receiving speed.



Fast



Medium



Slow



Very Low

Bluetooth protocol

Select the desired communication bluetooth protocol barcode

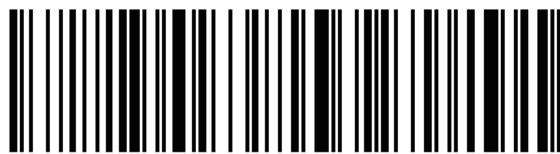

Bluetooth HID Mode



Bluetooth SPP Mode



Bluetooth BLE Mode

Note: Scan above barcode to enter the bluetooth searching state

Operating Mode

In normal mode, the scans are uploaded directly to computer via USB cable . If succeeds, barcode scanner will make a low-frequency short tone. If it fails, there will be three low frequency short tones to alarm. In normal mode, if fails, the data will be lost.You can scan below:



Normal Mode

If the transfer range is beyond Bluetooth wireless transfer range . storage mode is suggested, in which scans are stored in internal storage after being scanned.

In storage mode, if a barcode is scanned and the scanner will make a short tone and scans are automatically stored in scanner's internal storage.

If the internal storage is full, the scanner will emit three low-frequency short tones to alarm.



Storage Mode

By scan “Total amount of stored barcode” barcode, to check the total amount of scanned barcodes in storage:



Total amount of stored barcode

Upload the stored data by scanning the "Data Upload" barcode.



Data Upload

Note: When uploading data, please ensure the wireless signal is perfect, or upload after connecting with USB cable

By scanning "Clear Data" to clear the scans in storage, the cleared scans won't be uploaded once cleared.

Please confirm whether the scans have been uploaded before clear them.



Clear Data

Bluetooth Name Change Setting

A. Scan Bluetooth Name Change Set-up Barcode:

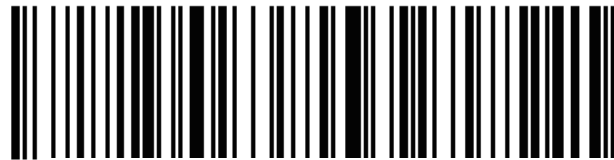

Bluetooth Name Change Set-up Barcode

B. Scan the user-defined barcode of bluetooth name within 16 characters (Symbology unlimited, letter, number or symbol works). If customer wants to change the bluetooth name as you like it, you should equipped with bar code generator yourself.

For example, Once you make a bar code of Scanner123, the bluetooth name of scanner would be changed as Scanner123 after scanning the bar code you made.



Scanner123

Note: Once initialized, the bluetooth name would revert to the default.



Initialization Set-up

Hide front and back characters

A: Scan "Hide front character" or "Hide back character" Setting Barcode



Hide front character



Hide back character

B: Scan hide quantity of characters

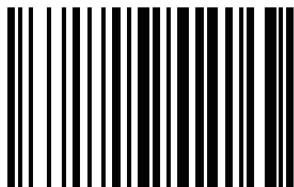

Hide 1 Character

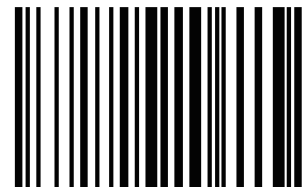

Hide 2 Characters

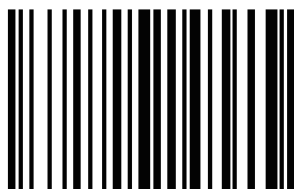

Hide 3 Characters

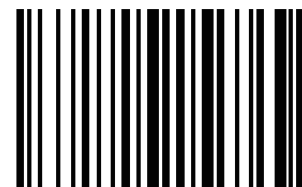

Hide 4 Characters

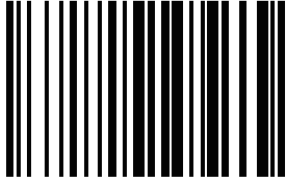

Hide 5 Characters

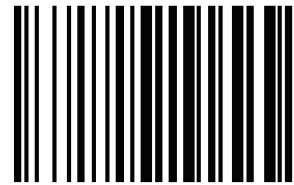

Hide 6 Characters

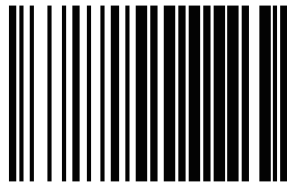

Hide 7 Characters

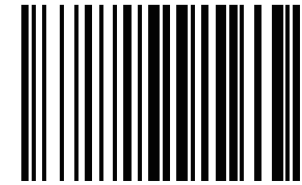

Hide 8 Characters

Note: If you want to cancel “Hide front and back characters” operation, please scan barcodes of “Hide front character” or “Hide back character” Setting Barcode

Set Prefix and Suffix Setting

A : Scan the "Allow for Prefix Adding" or "Allow for Suffix Adding" setting barcode



Allow for Prefix Adding



Allow for Suffix Adding

B : Select the desired contents of prefix or suffix (Appendix A)

Note: If you want to cancel Prefix or Suffix Adding operation, please scan barcodes of "Allow for Prefix Adding" or "Allow for Suffix Adding" "Setting Barcode once more

Appendix A:



SOH



STX



ERX



EOT



ENQ



ACK

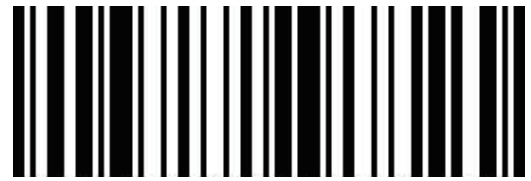

BEL

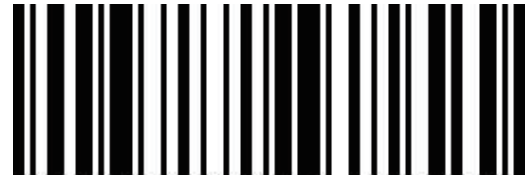

Back Space



LF

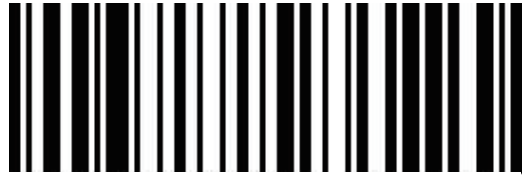

VT

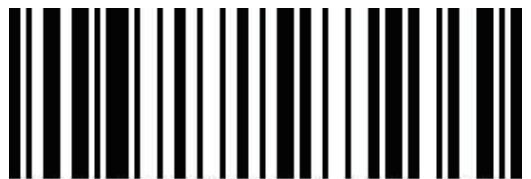

FF

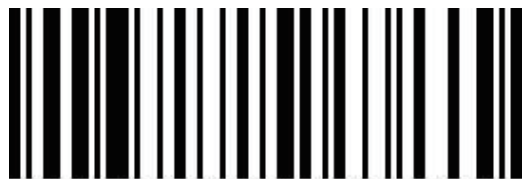

CR



Tab

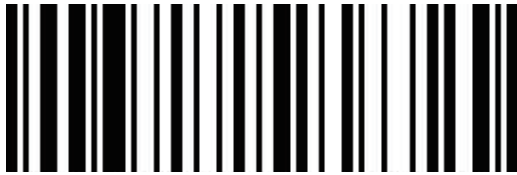

F1

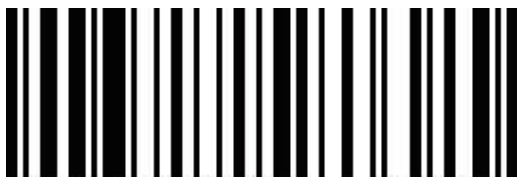

F2



F3



F4



F5



F6



F7



F8



F9



F10



F11



F12



FS

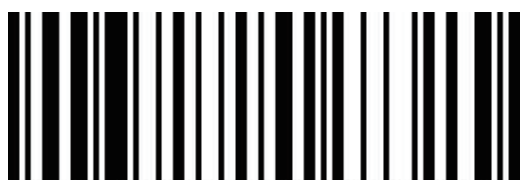

GS



RS



SUB



Esc



US

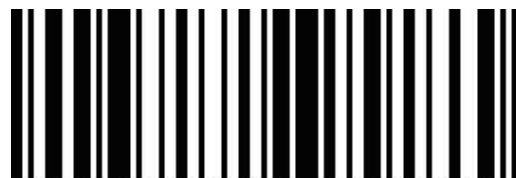

Blank



!

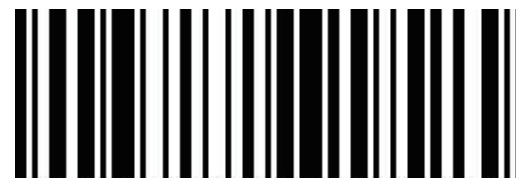

\"

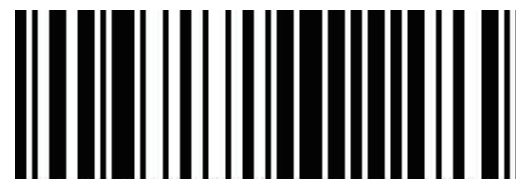

#

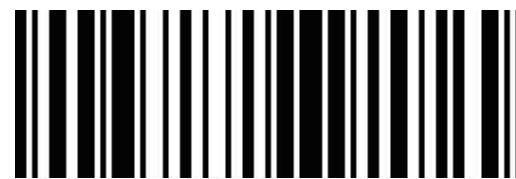

\$

Ring Barcode Scanner

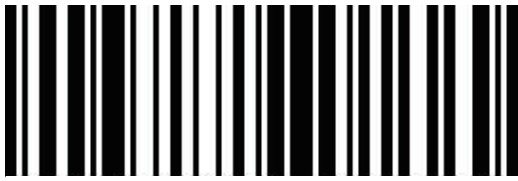

%



&



'



(



)

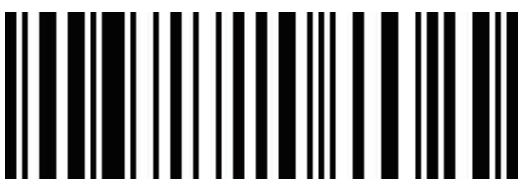

*

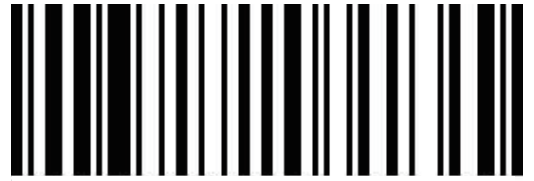

+

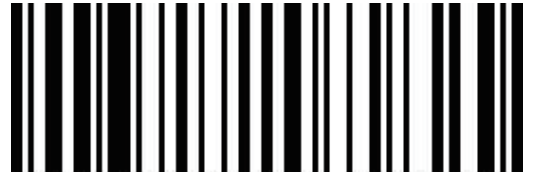

,



-



.



/



0

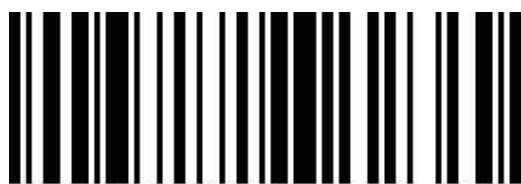

1

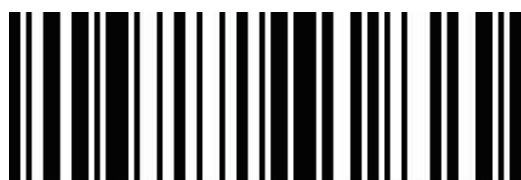

2



3



4



5



6



7



8



9



:



;



<

Ring Barcode Scanner



=



>

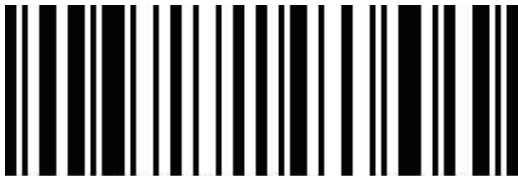

?



@



A



B



C



D



E



F



G



H



I

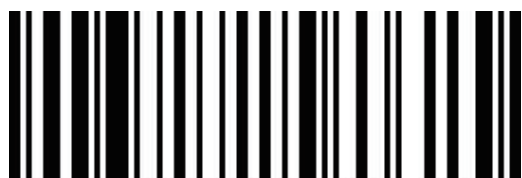

J

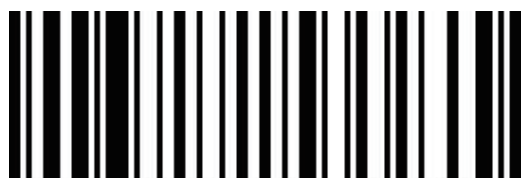

K



L

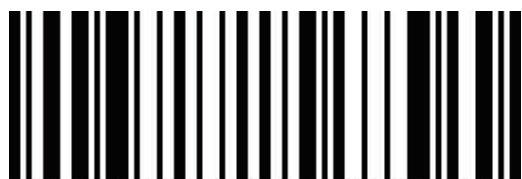

M



N

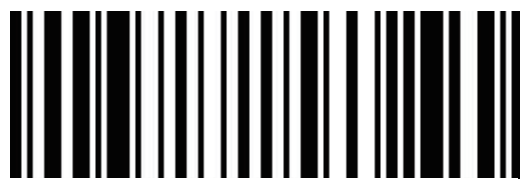

O

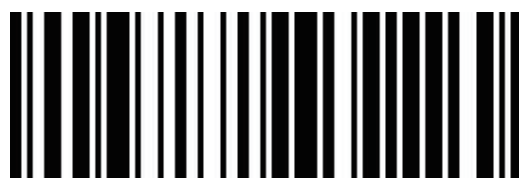

P



Q



R



S

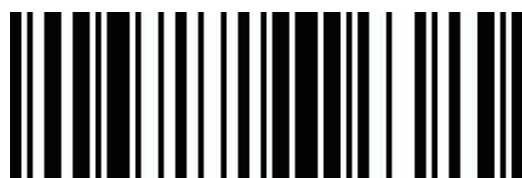

T



U



V



W



X



Y



Z

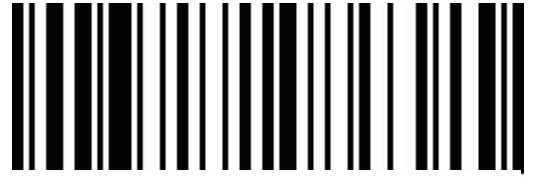

[

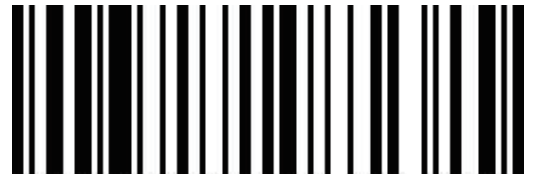

\



]



^



_



,



a

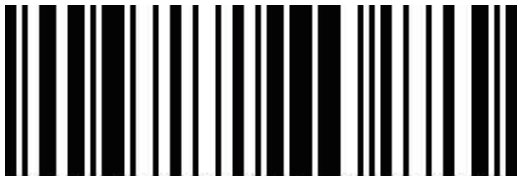

b



c

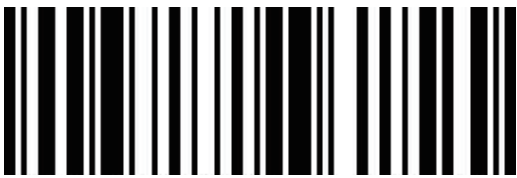

d

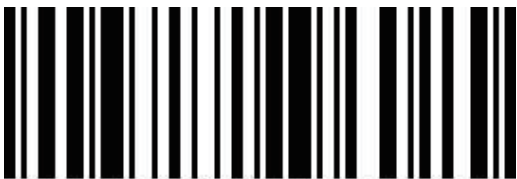

e



f



g

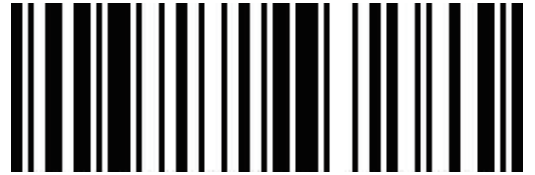

h



i



j



k



l

Ring Barcode Scanner



m



n



o



p



q



r



s



t



u



v



w



x



y



z



{



|



}



~



DEL

FAQ

▶ **What should I do if I can not pair scanner with Bluetooth devices?**

A. Please make sure that scanner is in the matching state under corresponding bluetooth protocol

B. If the devices has connected successfully with other barcode scanner via bluetooth, or other devices. Please delete the bluetooth connection record before connecting.

C. The wireless module has been damaged

▶ **Why some symbologies fail to be read?**

The scanning module does not support the symbology or the symbology has been turned off, please contact with the vendor to turn on the code system.

▶ **Why scans fails to be uploaded to computer or smartphone ?**

A. Please make sure if they have been successfully paired, if yes, the LED indicator of the bluetooth barcode scanner is blue.

B. Please check if it is in "Storage Mode". (In "Storage Mode" scans won't be uploaded automatically, please scan "Data Upload" setting code manually to upload the scan is required)

C. Please switch to "Normal Mode" to scan and upload simultaneously.

D. The wireless module has been damaged

▶ **Why the barcode content is not correct?**

Please make sure that the PC or smartphone keyboard language is the same as Barcode Scanner language.

▶ **Why does the scanner cannot charge?**

A. Please select correct charger.

B. The charging circuit or battery has been damaged.

▶ **How to change more scanning settings?**

Please contact your barcode scanner vendor.

Buzzer

Sound Type	description
a long sound (First low then high frequency)	Means power on
a long sound (First high then low frequency)	Means power off
a short sound (low frequency)	Means read barcode
a short sound (First low then high frequency)	Means data has been stored
a short sound (First high then low frequency)	Means scan the set-up barcode
a short sound (low frequency)	Means wireless transmission failed or cache is full

During normal usage or start-up process,if the buzzer continuously makes five times long sound(low frequency) ,then automatically power off. It means the power capacity is too low and need to be charged before use.

LED Indicator light

light color	description
two blue lights flicker alternately	Enter into HID pairing state
two blue lights flicker at the same time	Enter into BLE pairing state
blue light on the right flicker	Enter into SPP pairing state
red light always on	Charging state,after full,it will be off
red light flickers	Poor battery contact
green light on and off immediately	Read barcode successfully and make a short sound



Battery power display



Newland

SCANNING MADE SIMPLE

Newland EMEA HQ

+31 (0) 345 87 00 33
info@newland-id.com
newland-id.com

D-A-C-H

+49 (0) 6182 82916-16
info@newland-id.de

Benelux

+31 (0) 345 87 00 33
benelux@newland-id.com

Italy

+39 (0) 342 0562227
italy@newland-id.com

United Kingdom

+44 (0) 1442 212020
sales@newland-id.co.uk

South Africa

Gauteng: +27 (0) 11 553 8010
Cape Town: +27 (0) 21 9140819
info@newland-id.co.za

Turkey

+90 (0) 544 538 40 49
turkey@newland-id.com

France

+39 (0) 345 8804096
france@newland-id.com

Ibérica

+31 (0) 345 87 00 33
info@newland-id.com

Nordic & Baltic

+46 (0) 70 88 47 767
nordic@newland-id.com

Russia

+31 (0) 345 87 00 33
russia@newland-id.com

Middle East

+39 (0) 345 8804096
middleeast@newland-id.com

Iran

+90 (0) 544 538 40 49
iran@newland-id.com